



**INTRODUCTION.**

Thank you for choosing the **Arising Star** ARTF by SEAGULL MODELS. The **Arising Star** was designed from the ground up with the beginner flyer in mind. It is a High-wing aeroplane which is easy to fly and quick to assemble. The airframe is conventionally built using balsa, plywood and veneer to make it stronger than the average ARTF, yet the design allows the aeroplane to be kept light. You will find that most of the work has been done for you already. The pushrods are pre-made to the correct lengths, the motor mount has been fitted and the hinges are pre-installed and pinned for security. Flying the **Arising Star** is simply a joy.

This instruction manual is designed to help you build a great flying aeroplane. Please read this manual thoroughly before starting assembly of your **Arising Star**. Use the parts listing below to identify all parts.

**WARNING.**

Please be aware that this aeroplane is not a toy and if assembled or used incorrectly it is capable of causing injury to people or property. **WHEN YOU FLY THIS AEROPLANE YOU ASSUME ALL RISK & RESPONSIBILITY.**

If you are inexperienced with basic R/C flight we strongly recommend you contact your R/C supplier and join your local R/C Model Flying Club. R/C Model Flying Clubs offer a variety of training procedures designed to help the new pilot on his way to successful R/C flight. They will also be able to advise on any insurance and safety regulations that may apply.

**ADDITIONAL ITEMS REQUIRED.**

- .40-.46 cu. in 2-stroke engine.
- .50 cu. in 4-stroke engine.
- 4-channel radio with four servos.
- Glow plug to suit engine.
- Propeller to suit engine.
- Protective foam rubber for radio system.
- Silicone fuel line.
- Stick-on weights for balance (If necessary).

**TOOLS & SUPPLIES NEEDED.**

- Thick cyanoacrylate glue.
- 30 minute epoxy.
- 6 minute epoxy.
- Hand or electric drill.
- Assorted drill bits.
- Modelling knife.
- Straight edge ruler.
- 2mm ball driver.
- Phillips head screwdriver.
- 220 grit sandpaper.
- 90° square or builder's triangle.
- Wire cutters.
- Masking tape & T-pins.
- Thread-lock.
- Paper towels.

**PARTS LISTING.****FUSELAGE ASSEMBLY.**

- (1) Fuselage.
- (1) Pre-installed throttle pushrod & tube.
- (1) Pre-installed servo tray.
- (1) Pre-installed motor mount.
- (1) Pre-installed rudder pushrod.
- (1) Pre-installed elevator pushrod.

**WING ASSEMBLY.**

- (1) Right wing half with pre-installed aileron.
- (1) Left wing half with pre-installed aileron.
- (1) Plywood wing dihedral brace.
- (1) Covering strip for centre section joint.

**TAIL SECTION ASSEMBLY.**

- (1) Vertical stabilizer with pre-installed rudder.
- (1) Horizontal stabilizer with pre-installed elevator halves.

**NOTE:** To avoid scratching your new aeroplane we suggest that you cover your workbench with an old towel. Keep a couple of jars or bowls handy to hold the small parts after you open the bags.

Please trial fit all parts. Make sure you have the correct parts and that they fit and are aligned properly before gluing! This will ensure proper assembly as the **Arising Star** is made from natural materials and minor adjustments may have to be made.

The paint and plastic parts used in this kit are fuel proof. However, they are not tolerant of many harsh chemicals including the following: paint thinner, cyano-acrylate glue accelerator, cyanoacrylate glue de-bonder and acetone. Do not let these chemicals come in contact with the colours on the covering and the plastic parts.

## WING ASSEMBLY.

**NOTE:** We highly recommend using 30 minute epoxy as it is stronger and provides more working time, allowing the builder to properly align the parts. Using fast cure epoxy when joining the wing halves could result in the glue drying before the wing halves are aligned properly which may result in failure of the wing centre section during flight.

☐ 1) Test fit the wing tube into each wing half. The brace should slide in easily up to the centreline that you drew. If not, use 220 grit sandpaper with a sanding block and sand down the edges and ends of the brace until it fits properly.

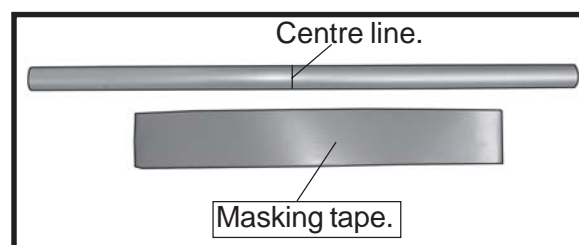

☐ 2) Remove the brace when satisfied with its fit in each wing half. Coat both sides of one half of the dihedral brace with 30 minute epoxy. Next, pour some epoxy into the dihedral box in one wing panel. Make sure you cover the top and bottom as well as the sides of the dihedral brace. Use enough epoxy to fill any gaps.

Carefully slide the two wing halves together and firmly press them together, allowing the excess epoxy to run out. There should not be any gap in the wing halves. Use rubbing alcohol and a paper towel to clean up any excess epoxy.

Apply masking tape at the wing join to hold the wing halves together securely.

☐ 3) Peel off the backing from the self adhesive covering strip. Apply the strip to the centre section of the wing starting from the bottom trailing edge. Wrap the strip all the way around the wing until it meets the trailing edge again. Trim off any excess strip.

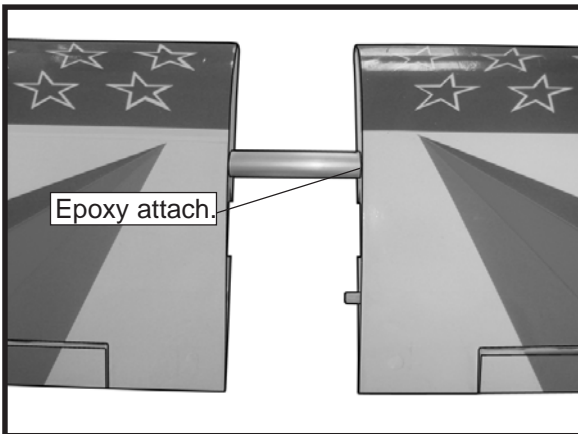
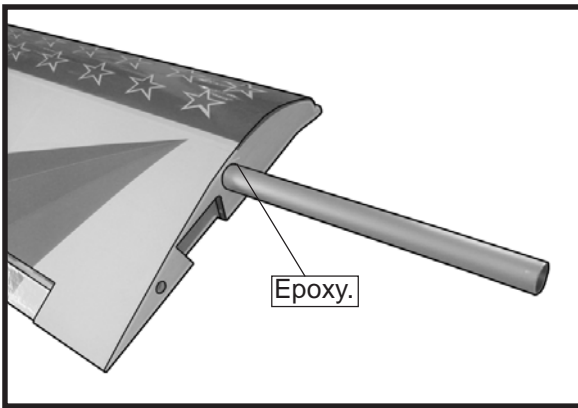

□ 4) Once the epoxy has cured, trial fit both wing halves together. The centre ribs should fit together flush with no gaps. If gaps do exist, use 220 grit sandpaper and sand down the high spots on the root ribs and the wing joiner until a proper fit is achieved. The correct amount of dihedral is ready-built into the wings. With one wing half laid flat on the table, the other wing tip should be off the table surface. If this needs to be adjusted, you may do so by sanding small amounts from the centre ribs or dihedral brace.

□ 5) Carefully apply masking tape around the top and bottom edge of the root rib of each wing half to protect them from damage caused by epoxy.

□ 6) Mix a generous amount of 30 minute epoxy. Coat the exposed half of the dihedral brace, and the remaining wing joiner box and both root ribs with epoxy. Slide the two wing halves together and carefully align them at the leading and trailing edges. Wipe away any excess epoxy using paper towels. Use masking tape wrapped around the center section to hold the halves in place until the epoxy cures.

□ 7) When the epoxy has cured, carefully remove the masking tape from the wing.

□ 8) Peel off the backing from the self adhesive covering strip. Apply the strip to the center section of the wing starting from the bottom trailing edge. Wrap the strip all the way around the wing until it meets the trailing edge again. Trim off any excess strip.

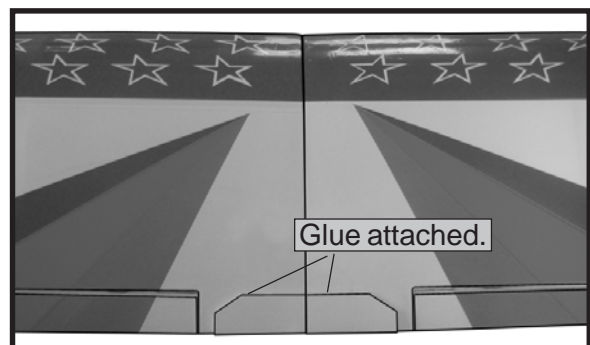
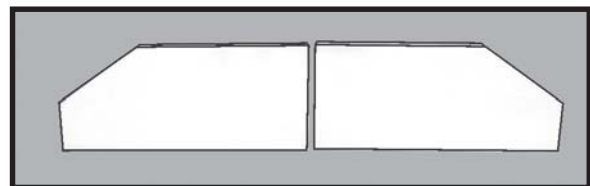
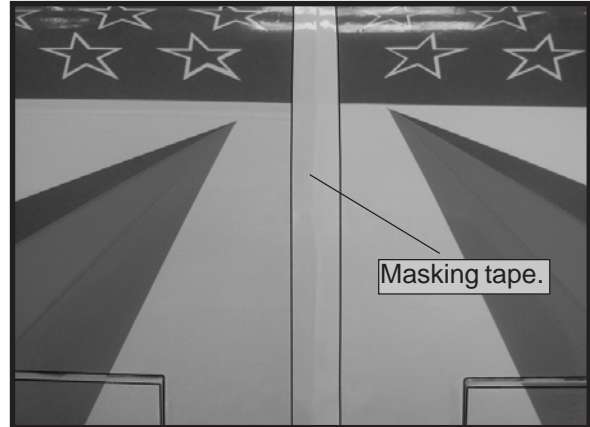

**INSTALLING THE AILERON SERVO MOUNT.**

□ 1) Install the rubber grommets and brass collets onto the aileron servo. Test fit the servo into the aileron servo mount.

⚠ Because the size of servos differ, you may need to adjust the size of the precut opening in the mount. The notch in the sides of the mount allow the servo lead to pass through.

□ 2) Remove the aileron servo. Place the mount onto the wing, aligning the cutout in the mount with the cutout in the wing. The two notches in the mount should face the leading edge of the wing.

□ 3) While holding the servo mount firmly in place, trace around it using a pen.



- ❑ 4) Remove the mount, and using a modeling knife, carefully remove the covering from inside the outline you drew.
- ❑ 5) Using 6 Minute Epoxy, glue the servo mount into place. Remove any excess epoxy using a paper towel and rubbing alcohol. Use pieces of masking tape to hold the tray in place until the epoxy fully cures.

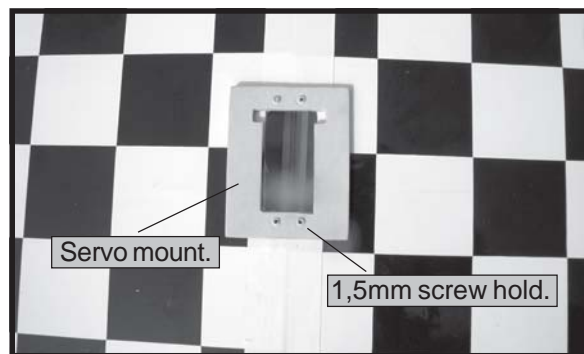
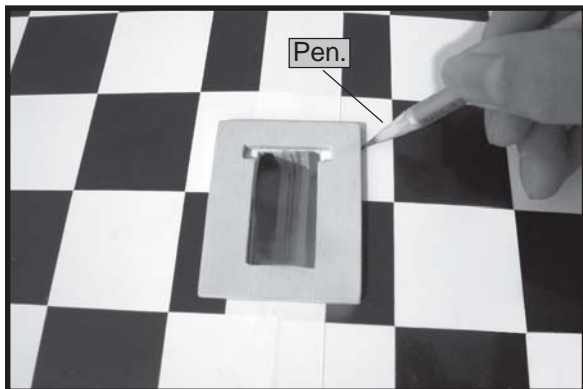

### INSTALLING THE AILERON SERVO.

Install the aileron servo into the servo mount, with the output shaft towards the leading edge of the wing, using the wood screws provided with your radio system. Drill 1/16" pilot holes through the mount before installing the screws. This will prevent the wood from splitting.



### INSTALLING THE AILERON LINKAGE.

- ❑ 1) Thread one nylon adjustable control horn onto each aileron torque rod. Thread the horns on until they are flush with the ends of the torque rods.
- ❑ 2) Thread one nylon clevis at least 5/16" onto each of the two threaded wires.
- ❑ 3) With the aileron servo centered, install the servo arm onto the servo. The arm should be installed so it is parallel with the trailing edge of the wing.

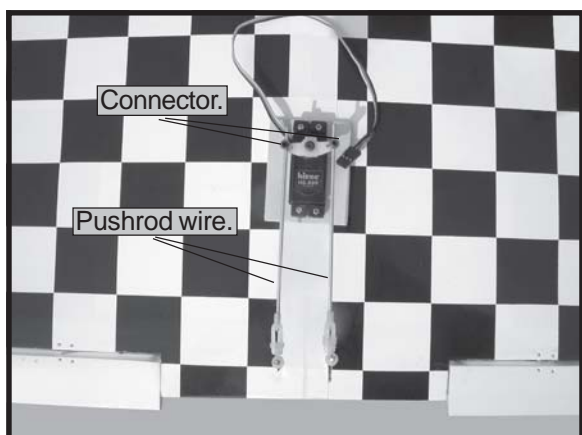
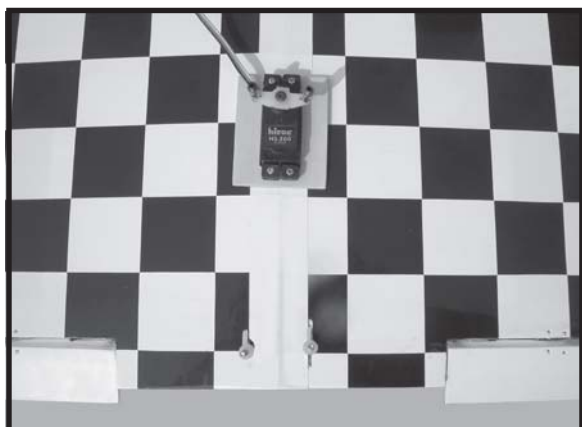
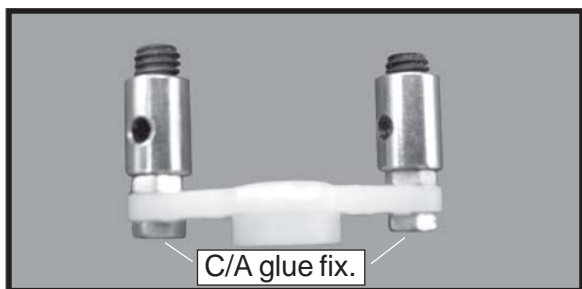

□ 4) Slide the pushrod wires through the connectors as shown.

□ 5) With both the aileron servo and the ailerons centered. Tighten the set screws on the connectors.

**INSTALLING THE MAIN GEAR WIRES.**

□ 1) Using a modeling knife, remove the covering from over the two main gear mounting slots located in the bottom of the fuselage.

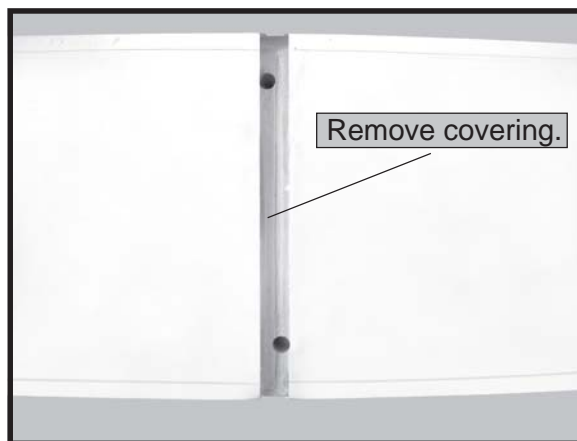

□ 2) Using the two landing gear straps as a guide, mark the locations of the four 3mm x 12mm mounting screws onto the fuselage surface.

□ 3) The landing gear wire is held in place using two nylon landing gear straps and four 3mm x 12mm wood screws.

The straps should be located equal distance from the inside and outside ends of the wire.

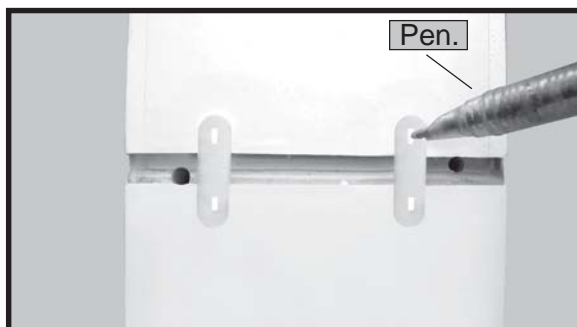

□ 4) Insert the main gear wire into the mounting slot.

□ 5) Remove the two straps and the gear wire. Drill four 3/32" pilot holes into the fuselage for the wood screws.

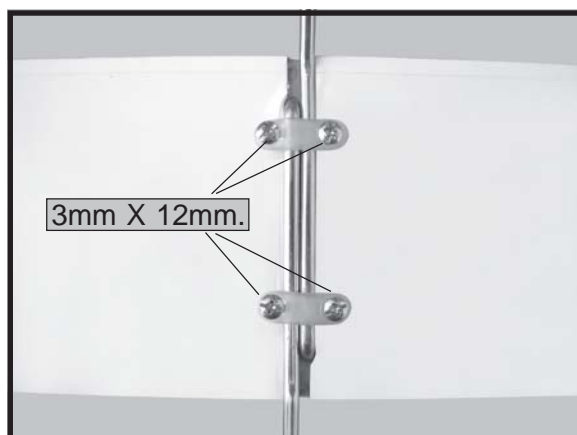

**NOSE GEAR INSTALLATION.**

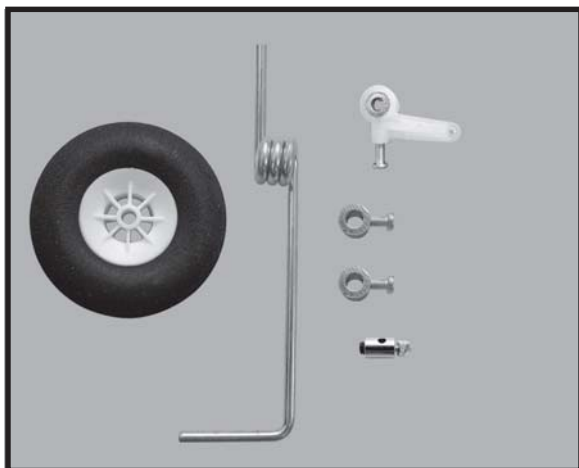

**TOOLS REQUIRED**

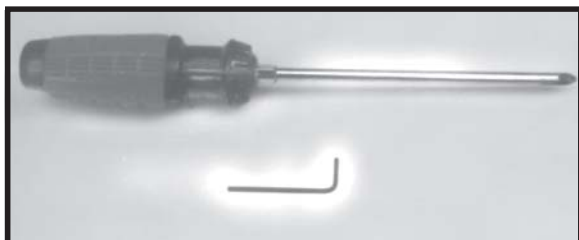

Installing steering arm as follow.



Adjust the nose gear steering arm until the arm is parallel with the fire wall.

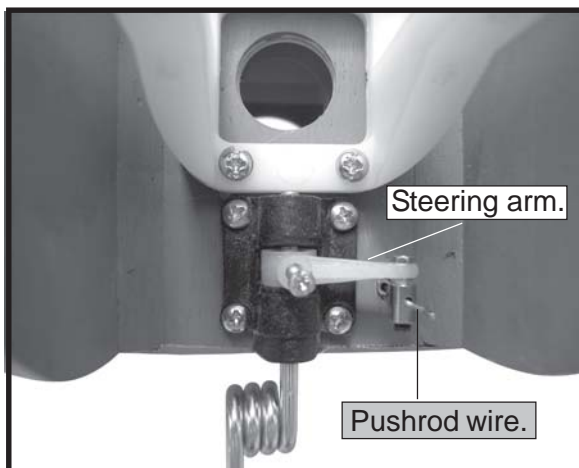

**FUEL TANK.**

**INSTALLING THE STOPPER ASSEMBLY.**

- 1) Using a modeling knife, carefully cut off the rear portion of **one** of the two nylon tubes leaving 1/2" protruding from the rear of the stopper. This will be the fuel pick up tube.
- 2) Using a modeling knife, cut one length of silicon fuel line (not included) to 2-1/4" long. Connect one end of the line to the weighted fuel pickup and the other end to the nylon pickup tube.
- 3) Carefully bend the second nylon tube up at a 45° angle. This tube is the vent tube.

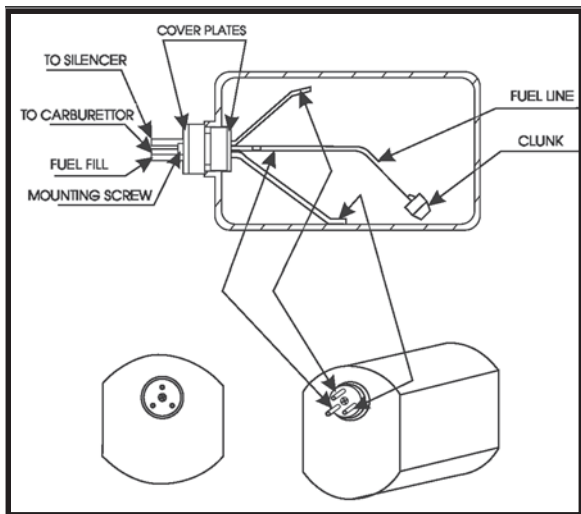

- 4) Carefully heat the vent tube using a heat gun or lighter to permanently set the angle of the tube.

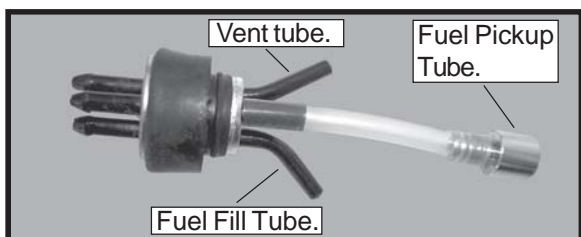

When the stopper assembly is installed in the tank, the top of the vent tube should rest just below the top surface of the tank. It should not touch the top of the tank.

□ 5) Test fit the stopper assembly into the tank. It may be necessary to remove some of the flashing around the tank opening using a modeling knife. If flashing is present, make sure none falls into the tank.

□ 6) With the stopper assembly in place, the weighted pickup should rest about 3/8" away from the rear of the tank and move freely inside the tank. The top of the vent tube should rest just below the top of the tank. It should not touch the top of the tank.

□ 7) When satisfied with the alignment of the stopper assembly tighten the 3mm x 20mm machine screw until the rubber stopper expands and seals the tank opening. Do not overtighten the assembly as this could cause the tank to split.

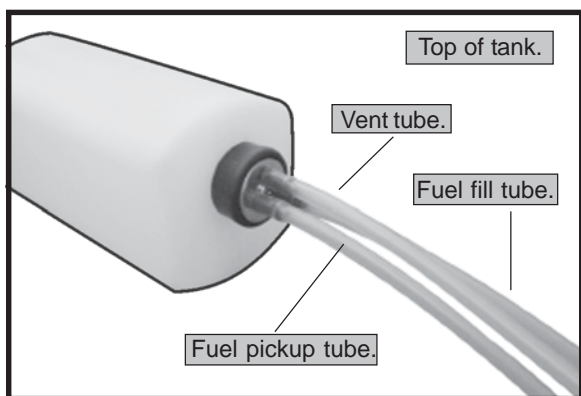

## INSTALLING THE FUEL TANK.

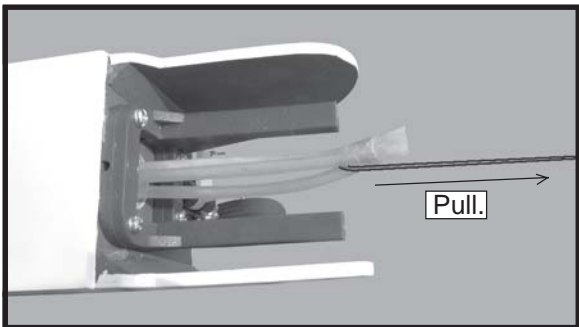
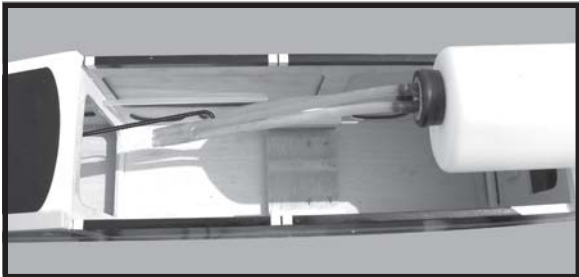
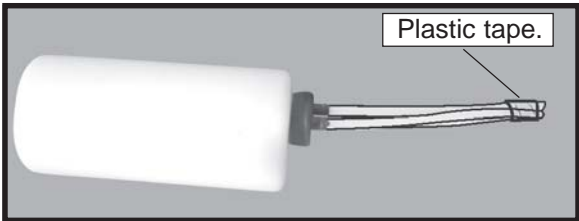
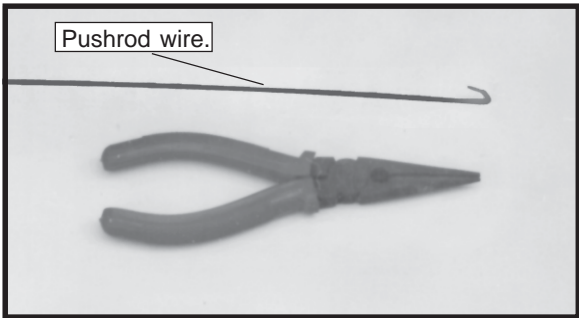

Use pieces off foam rubber to hold the tank in place. Be careful the tank or the foam doesn't interfere with the pushrods. Cut the fuel line in the middle of the loop. Keep track of which one is for the fuel pick-up and which one is for the muffler pressure.

 Blow through the tubes to make sure the lines have not become kinked during installation.



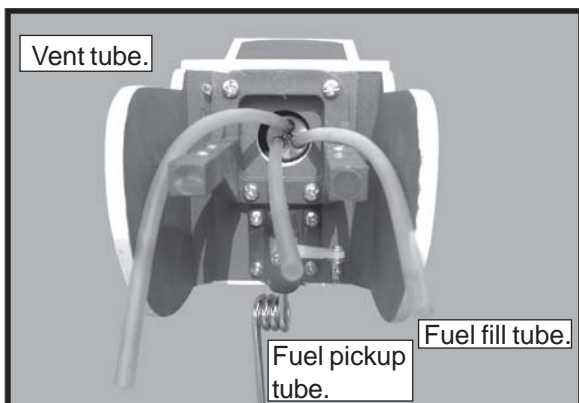
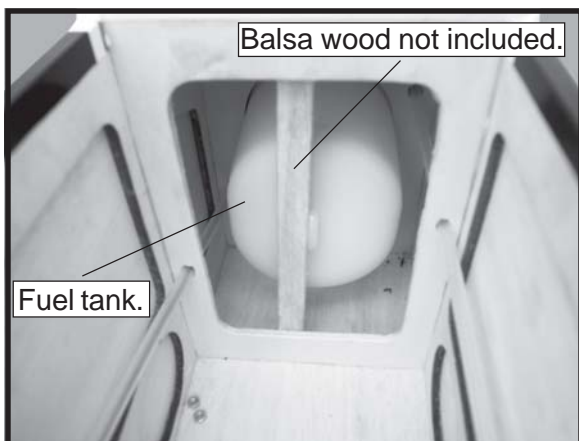

**MOUNTING THE ENGINE.**

□ 1) Install the pushrod housing through the predrilled hole in the firewall and into the servo compartment. The pushrod housing should protrude 1/4" out past the front of the firewall.

Make a Z-Bend 1/4" from one end of the plain wire pushrod.

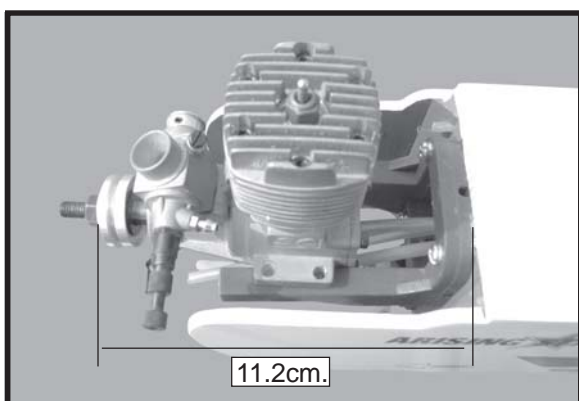

□ 2) Place your engine onto the engine mount. Adjust the engine is centered of the edges of the engine case.

□ 3) When you are satisfied with the alignment, mark the locations of the engine mounting.

□ 4) Remove the engine. Using an drill bit, drill the mounting holes through the engine mount at the four locations marked.

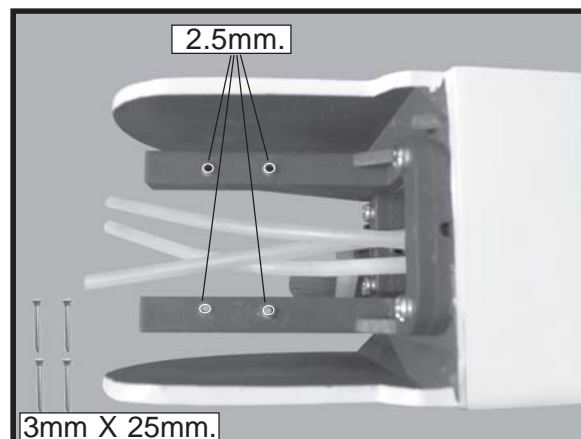

□ 5) Bolt the engine to the engine mount using the four machine screws. Double check that all the screws are tight before proceeding.

□ 6) Attach the Z-Bend in the pushrod wire to the throttle arm on the carburetor. You will need to remove the throttle arm from the carburetor to be able to attach the Z-bend. When complete, reattach the throttle arm to the carburetor.

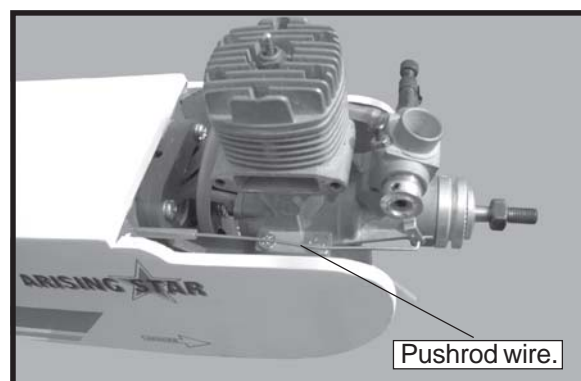
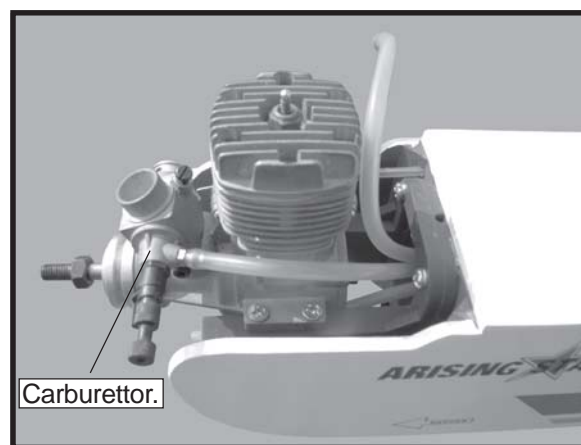

**INSTALLING THE SPINNER.**

Install the spinner backplate, propeller and spinner cone. The spinner cone is held in place using two 3mm x 12mm wood screws.

 The propeller should not touch any part of the spinner cone. If it does, use a sharp modeling knife and carefully trim away the spinner cone where the propeller comes in contact with it.

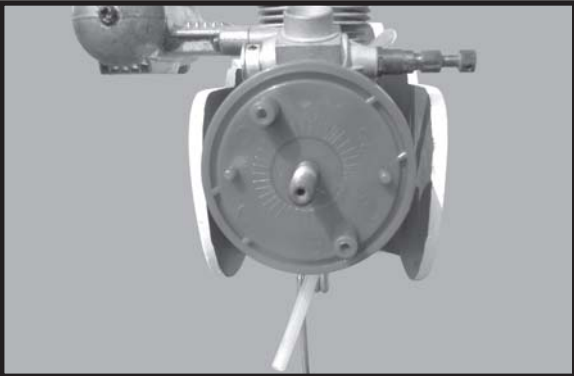

**INSTALLING THE SWITCH.**

Install the switch into the precut hole in the servo tray, in the fuselage, from the bottom. Use the two screws provided with the switch to secure it in place. Drill two 3/32" holes through the tray for the screws to pass through.

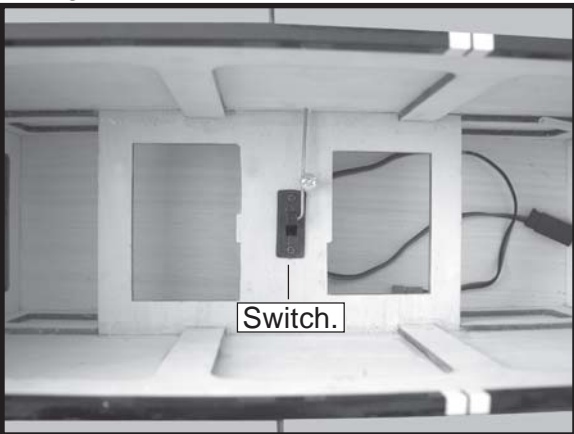

**INSTALLING THE FUSELAGE SERVOS.**

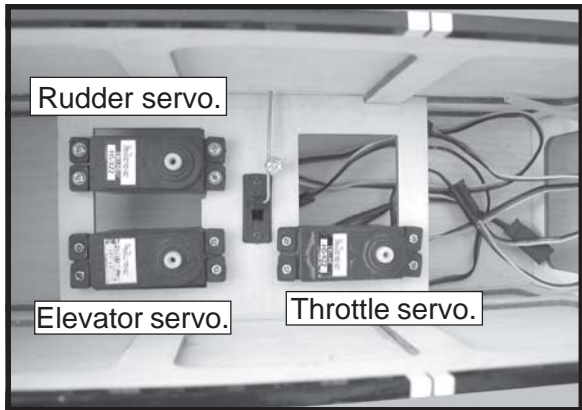

**HORIZONTAL STABILIZER.**

**PARTS REQUIRED**

- {1} Horizontal Stabilizer with Elevator Halves

**ALIGNING THE HORIZONTAL STABILIZER.**

- 1) Using a ruler and a pen, locate the centerline of the horizontal stabilizer, at the trailing edge, and place a mark. Use a triangle and extend this mark, from back to front, across the top of the stabilizer. Also extend this mark down the back of the trailing edge of the stabilizer.

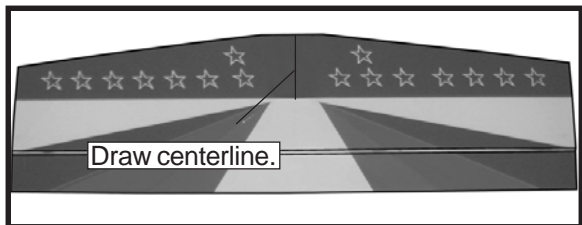

-  The top of the stabilizer does **not** have the hinge pins exposed.

- 2) Using a modeling knife, carefully remove the covering from over the vertical stabilizer mounting slot in the top of the fuselage.

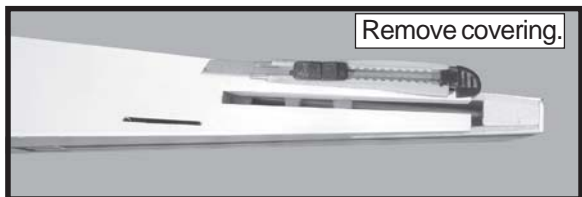

- 3) Slide the stabilizer into place in the pre-cut slot in the rear of the fuselage. The stabilizer should be pushed firmly against the front of the slot.

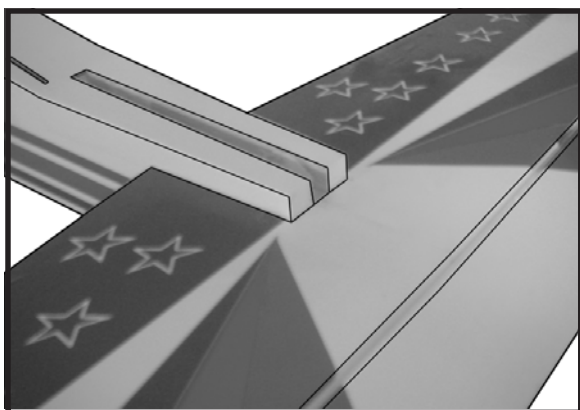

□ 4) With the stabilizer held firmly in place, use a pen and draw lines onto the stabilizer where it and the fuselage sides meet. Do this on both the right and left sides and top and bottom of the stabilizer.

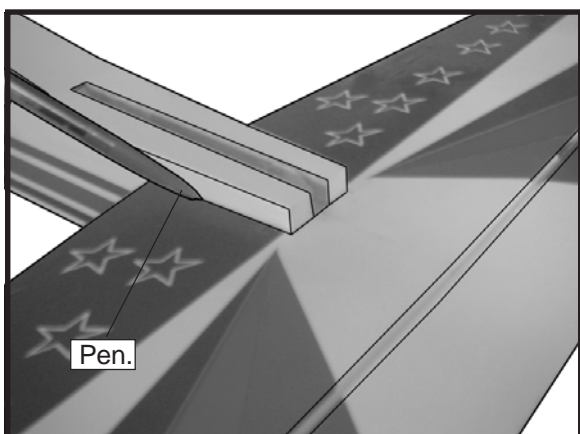

□ 5) Remove the stabilizer. Using the lines you just drew as a guide, carefully remove the covering from between them using a modeling knife.

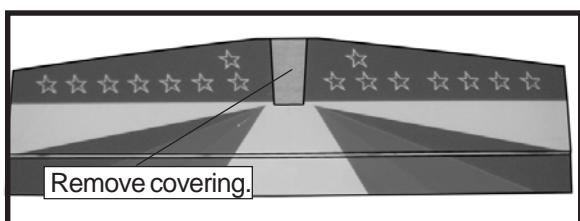

⚠ When cutting through the covering to remove it, cut with only enough pressure to only cut through the covering itself. Cutting into the balsa structure may weaken it.

□ 6) Using a modeling knife, carefully remove the covering that overlaps the stabilizer mounting platform sides in the fuselage. Remove the covering from both the top and the bottom of the platform sides.

□ 7) When you are sure that everything is aligned correctly, mix up a generous amount of 30 Minute Epoxy. Apply a thin layer to the top and bottom of the stabilizer mounting area

and to the stabilizer mounting platform sides in the fuselage. Slide the stabilizer in place and realign. Double check all of your measurements once more before the epoxy cures. Hold the stabilizer in place with T-pins or masking tape and remove any excess epoxy using a paper towel and rubbing alcohol.

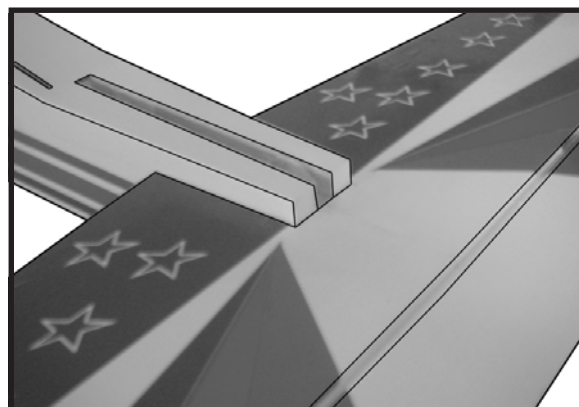

□ 8) After the epoxy has fully cured, remove the masking tape or T-pins used to hold the stabilizer in place. Carefully inspect the glue joints. Use more epoxy to fill in any gaps that may exist that were not filled previously and clean up the excess using a paper towel and rubbing alcohol.

**VERTICAL STABILIZER INSTALLATION.**

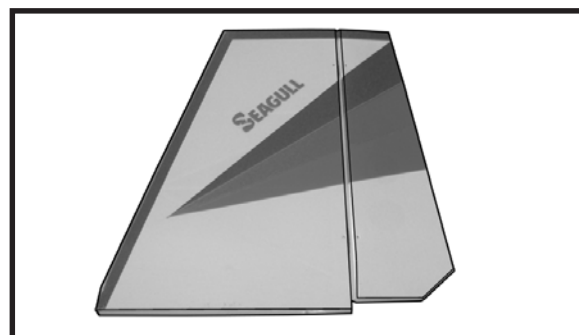

□ 1) Slide the vertical stabilizer into the slot in the top of the fuselage. The bottom edge of the stabilizer should also be firmly pushed against the top of the horizontal stabilizer.

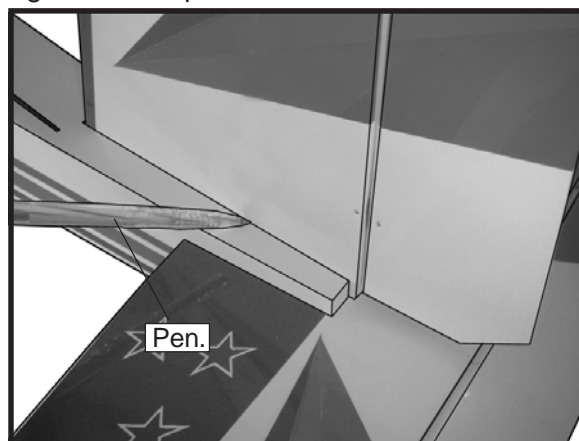

- 2) While holding the vertical stabilizer firmly in place, use a pen and draw a line on each side of the vertical stabilizer where it meets the top of the fuselage.

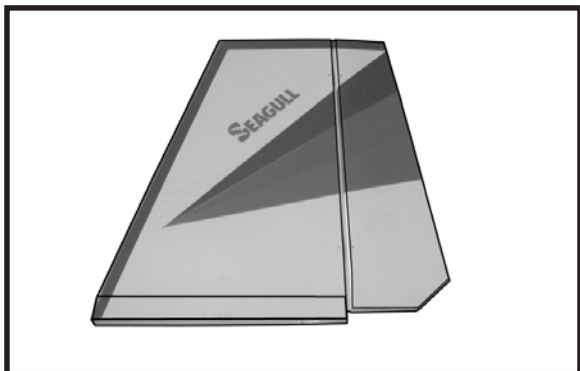

- 3) Remove the stabilizer. Using a modeling knife, remove the covering from below the lines you drew. Also remove the covering from the bottom edge of the stabilizer and the bottom and top edges of the filler block. Leave the covering in place on the sides of the filler block.

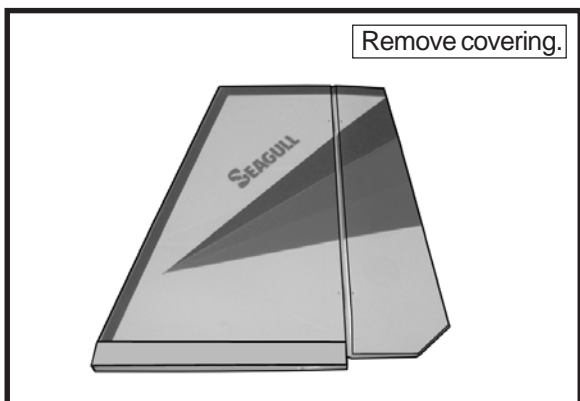

- ⚠ When cutting through the covering to remove it, cut with only enough pressure to only cut through the covering itself. Cutting into the balsa structure may weaken it.

- 4) Slide the vertical stabilizer back in place. Using a triangle, check to ensure that the vertical stabilizer is aligned 90° to the horizontal stabilizer.

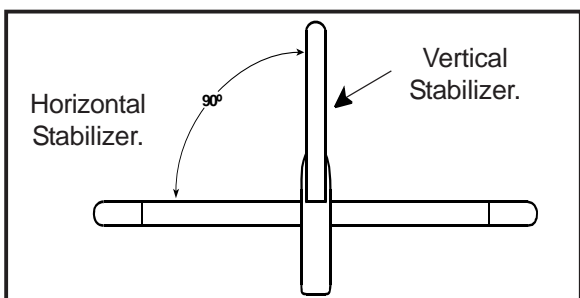

- 5) When you are sure that everything is aligned correctly, mix up a generous amount of 30 Minute Epoxy. Apply a thin layer to the mounting slot in the top of the fuselage and to the sides and bottom of the vertical stabilizer mounting area. Apply epoxy to the bottom and top edges of the filler block and to the lower hinge also. Set the stabilizer in place and realign. Double check all of your measurements once more before the epoxy cures. Hold the stabilizer in place with T-pins or masking tape and remove any excess epoxy using a paper towel and rubbing alcohol. Allow the epoxy to fully cure before proceeding.

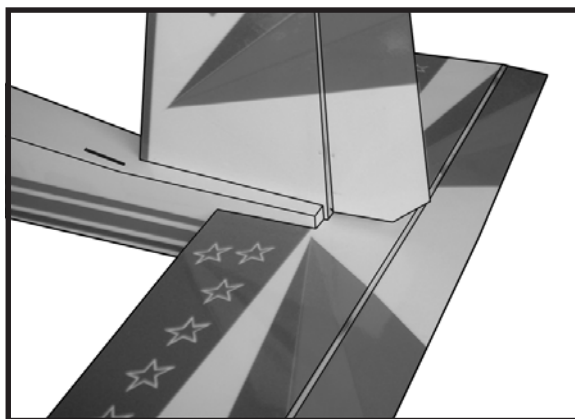

## CONTROL HORN INSTALLATION.

- 1) Locate the two nylon control horns, two nylon control horn backplates and four M2 x 12mm machine screws.

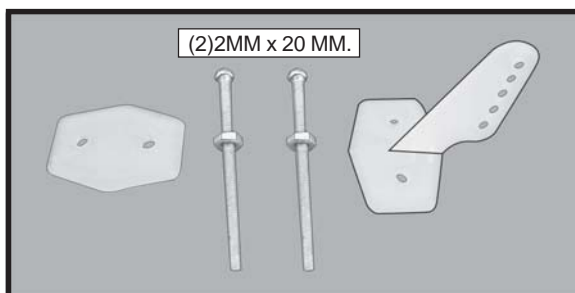

- 2) Position the elevator horn on the bottom side of elevator. The clevis attachment holes should be positioned over the hinge line.

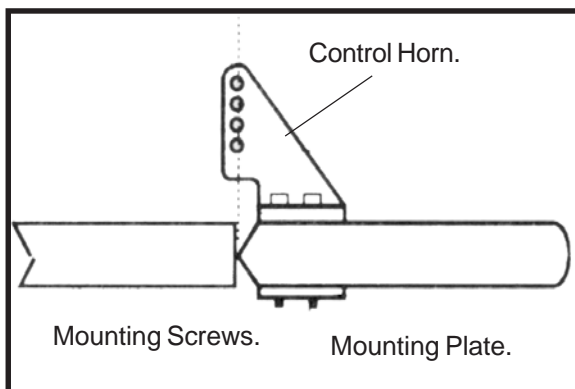



□ 3) Using a 1.5mm drill bit and the control horns as a guide, drill the mounting holes through the elevator halves.

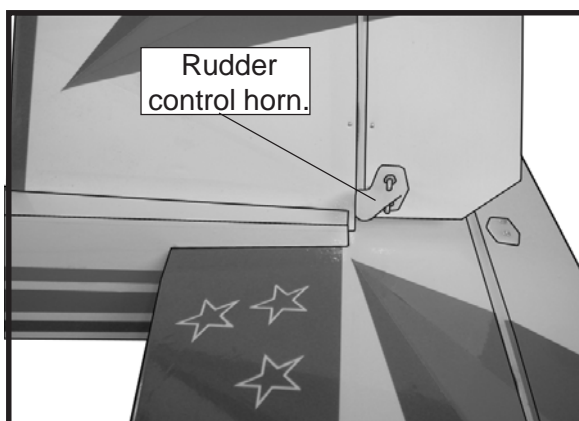
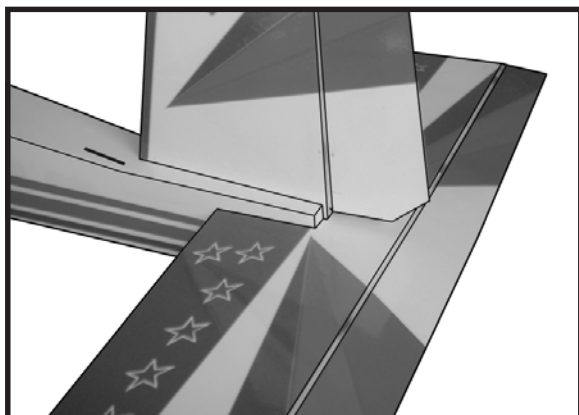

□ 4) Install the elevator control horn using the same method as with the rudder control horns.

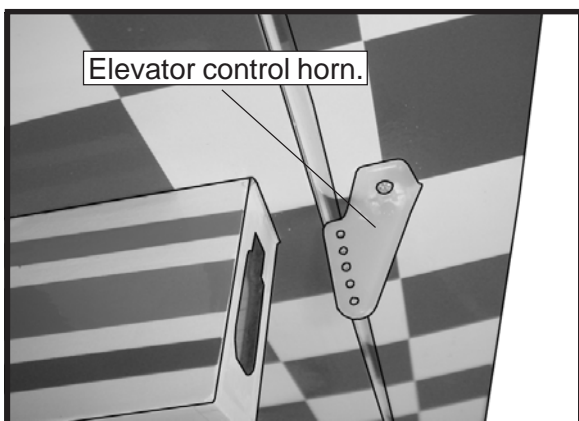

### PUSHROD INSTALLATION.

□ 1) Install the elevator pushrod into the fuselage. To help make installation easier, thread string down through the elevator pushrod exits and into the servo compartment in the fuselage. Tie the thread to the threaded pushrod wires of the elevator pushrod. Pull the pushrod through the exit slots.

□ 2) Thread two nylon clevises onto the threaded wires at least 10 turns. Attach the clevises to the elevator and rudder control horns. You may find it necessary to make slight bends in the wires so they will align with the control horns without binding.

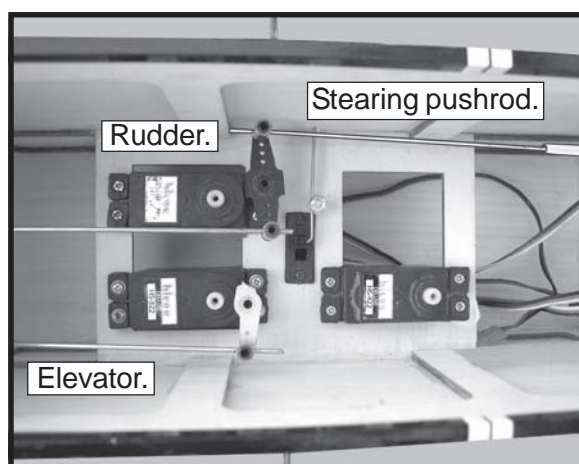
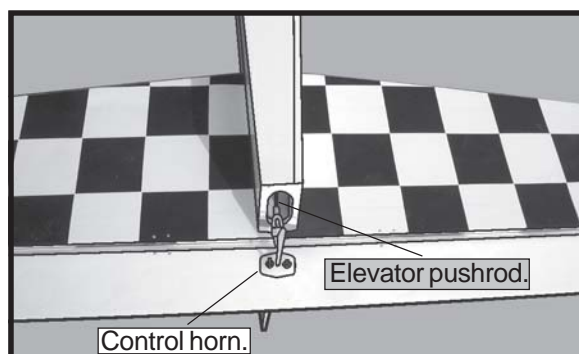
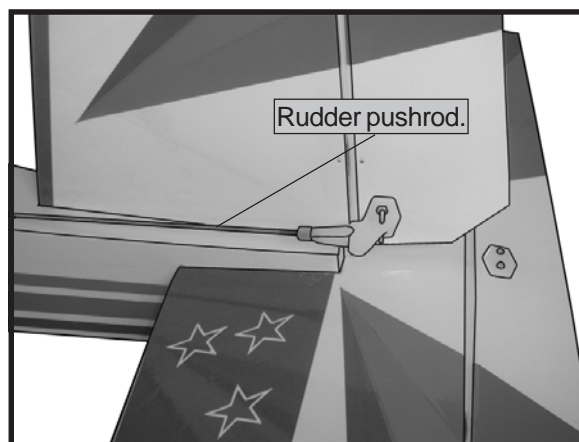

### THROTTLE SERVO INSTALLATION.

□ 1) Install adjustable servo connector in the servo arm.

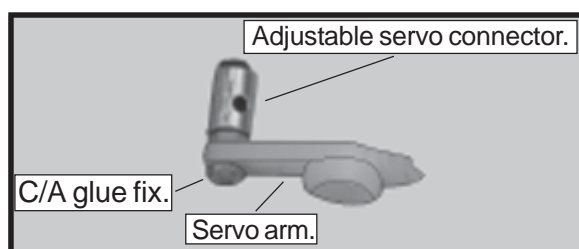



- 2) Install the rubber grommets and brass collets onto the throttle servo. Test fit the servo into the aileron servo mount.

Because the size of servos differ, you may need to adjust the size of the precut opening in the mount. The notch in the sides of the mount allow the servo lead to pass through.

- 3) Secure the servos with the screws provided with your radio system.

- 4) Install the pushrod throttle.

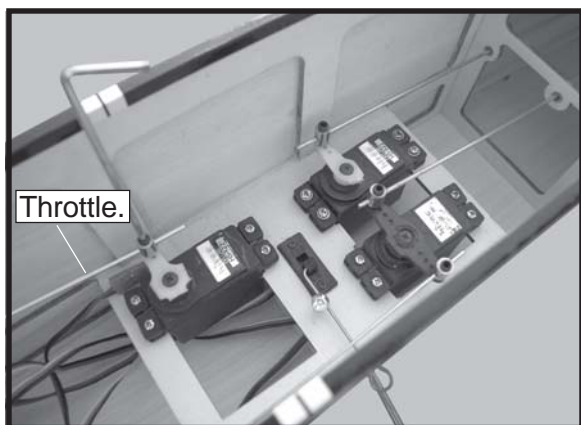

### INSTALLING THE MAIN GEAR WHEELS.

- 1) Slide one wheel collar with 3mm x 6mm set screw onto each axle. Push the wheel collars on as far as they will go and tighten the set screws.

 Be careful not to overtighten the set screws. Overtightening may cause the threads to strip.

- 2) Slide one 60mm diameter wheel onto each axle and push them up against the wheel collars. Slide the remaining wheel collars with 3mm x 6mm set screws onto the axles. Push them up against the wheels and tighten the

set screws. The wheels should spin free and not bind in any way. If they do bind, loosen the set screws in the outer wheel collars and move the collars out a small amount. Retighten the set screws.



### INSTALLING THE NOSE GEAR WHEEL.

Slide one 60mm diameter wheel onto the axle and push them up against the wheel collars. Slide the remaining wheel collars with 3mm x 6mm set screws onto the axles. Push them up against the wheels and tighten the set screws. The wheels should spin free and not bind in any way. If they do bind, loosen the set screws in the outer wheel collars and move the collars out a small amount. Retighten the set screws.



### INSTALLING THE RECEIVER AND BATTERY.

- 1) Plug the four servo leads and the switch lead into the receiver. Plug the battery pack lead into the switch also.

- 2) Wrap the receiver and battery pack in the protective foam rubber to protect them from vibration.

- 3) Position the battery pack in the fuel tank compartment and the receiver just behind the fuel tank. Use extra foam pieces to hold them in position.

 When balancing the airplane you may need to move the battery or receiver forward or after to achieve proper balance.

4) Using a 1/16" drill bit, drill a hole through the side of the fuselage, near the receiver, for the antenna to exit. Route the antenna out of the fuselage and secure it to the vertical stabilizer using a rubber band and a modified servo arm. See picture as below.

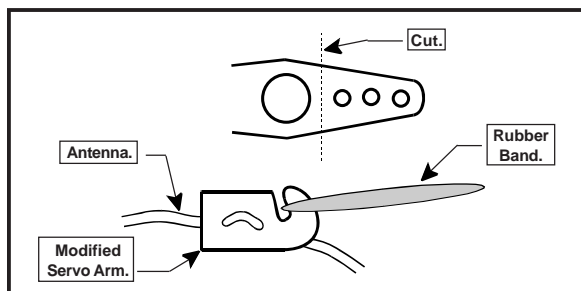

## ATTACHMENT WING-FUSELAGE.

See pictures below:

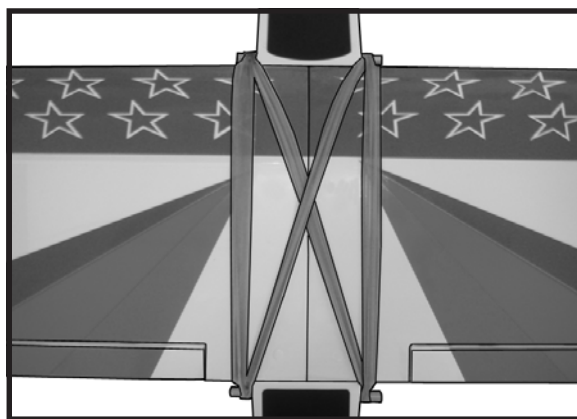
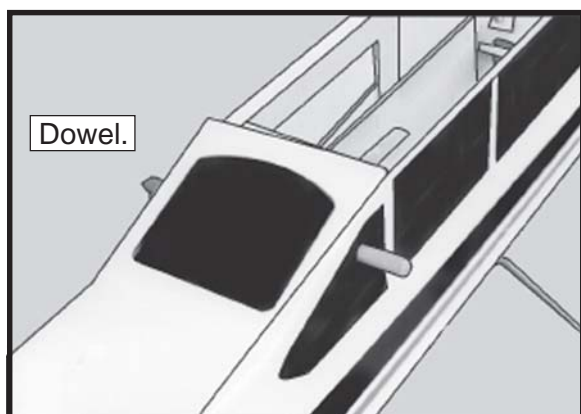
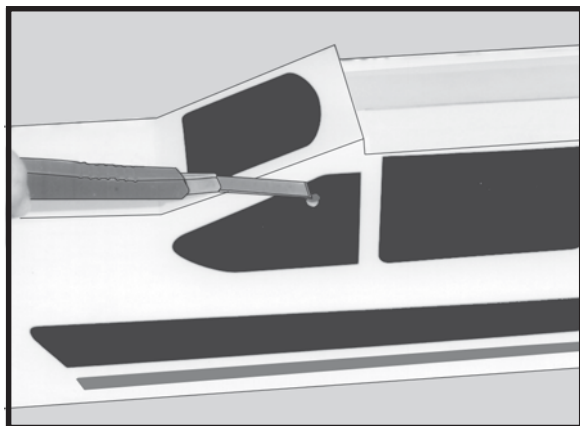

## BALANCING.

1) It is critical that your airplane be balanced correctly. Improper balance will cause your plane to lose control and crash. The center of gravity is located 2.5" to 3" back from the leading edge of the wing, at the fuselage sides. Balance the **Arising Star** with the fuel tank empty.

2) Mount the wing to the fuselage. Using a couple of pieces of masking tape, place them on the bottom side of the wing 2.5" to 3" back from the leading edge, at the fuselage sides.

3) Place your fingers on the masking tape and carefully lift the plane.

4) If the nose of the plane falls, the plane is nose heavy. To correct this first move the battery pack further back in the fuselage. If this is not possible or does not correct it, stick small amounts of lead weight on the fuselage sides under the horizontal stabilizer. If the tail of the plane falls, the plane is tail heavy. To correct this, move the battery and receiver forward or if this is not possible, stick weight onto the firewall or use a brass heavy hub spinner hub, similar to those offered by Harry Higley. When balanced correctly, the airplane should sit level or slightly nose down when you lift it up with your fingers.

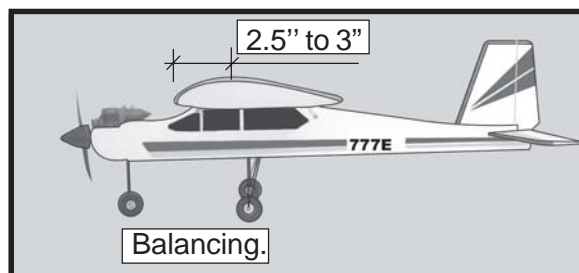

## CONTROL THROWS.

- 1) We highly recommend setting up the **Arising Star** using the control throws listed. We have listed control throws for both initial test flying/sport flying and aerobatic flying.
- 2) Turn on the radio system, and with the trim tabs on the transmitter in neutral, center the control surfaces by making adjustments to the clevises or adjustable servo connectors. The servo arms should be centered also.
- 3) When the elevator, rudder and aileron control surfaces are centered, use a ruler and check the amount of the control throw in each surface. **The control throws should be measured at the widest point of each surface!**

### INITIAL FLYING/SPORT FLYING

|           |            |           |
|-----------|------------|-----------|
| Ailerons: | 3/8" up    | 3/8" down |
| Elevator: | 3/8" up    | 3/8" down |
| Rudder:   | 1/2" right | 1/2" left |

### AEROBATIC FLYING

|           |          |           |
|-----------|----------|-----------|
| Ailerons: | 1/2" up  | 1/2" down |
| Elevator: | 5/8" up  | 5/8" down |
| Rudder:   | 1" right | 1" left   |

**Do not use the aerobatic settings for initial test flying or sport flying.**

- 4) By moving the position of the adjustable control horn out from the control surface, you will decrease the amount of throw of that control surface. Moving the adjustable control horn toward the control surface will increase the amount of throw.

## FLIGHT PREPARATION.

A) Check the operation and direction of the elevator, rudder, ailerons and throttle.

B) Plug in your radio system per the manufacture's instructions and turn every thing on.

C) Check the elevator first. Pull back on the elevator stick. The elevator halves should move up. If it they do not, flip the servo reversing switch on your transmitter to change the direction.

D) Check the rudder. Looking from behind the airplane, move the rudder stick to the right. The rudder should move to the right. If it does not, flip the servo reversing switch on your transmitter to change the direction.

E) Check the throttle. Moving the throttle stick forward should open the carburetor barrel. If it does not, flip the servo reversing switch on your transmitter to change the direction.

F) From behind the airplane, look at the aileron on the right wing half. Move the aileron stick to the right. The right aileron should move up and the other aileron should move down. If it does not, flip the servo reversing switch on your transmitter to change the direction.

## PREFLIGHT CHECK.

1) Completely charge your transmitter and receiver batteries before your first day of flying.

2) Check every bolt and every glue joint in the **Arising Star** to ensure that everything is tight and well bonded.

3) Double check the balance of the airplane. Do this with the fuel tank empty.

4) Check the control surfaces. All should move in the correct direction and not bind in any way.

5) If your radio transmitter is equipped with dual rate switches double check that they are on the low rate setting for your first few flights.

6) Check to ensure the control surfaces are moving the proper amount for both low and high rate settings.

7) Check the receiver antenna. It should be fully extended and not coiled up inside the fuselage.

8) Properly balance the propeller. An out of balance propeller will cause excessive vibration which could lead to engine and/or airframe failure.

***We wish you many safe and enjoyable flights with your Arising Star.***